

SH Series: Panel Mount Sockets, continued

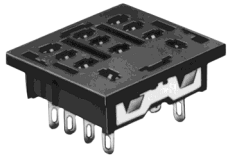

**SH3B-51**

<b>Style</b>	11-blade, panel mount
<b>Terminal</b>	Solder
<b>Electrical Rating</b>	300V, 10A
<b>Compatible Relay</b>	RH3B, RH2LB
<b>Hold-Down Spring</b>	SY4S-51F1 SY4S-02F1 for RH3B-4C
<b>Hold-Down Clip</b>	SFA-301 (top notch), SFA-302 (side notch)

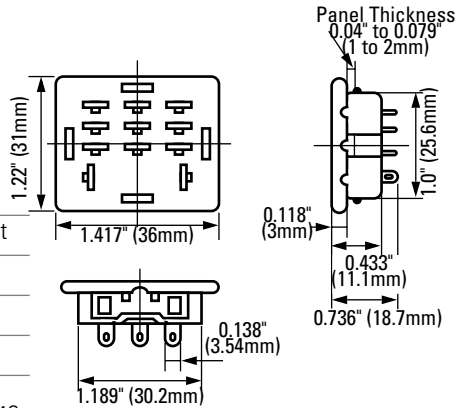

**Terminal Arrangement**

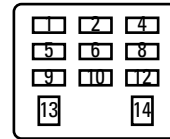

As Viewed from the Bottom

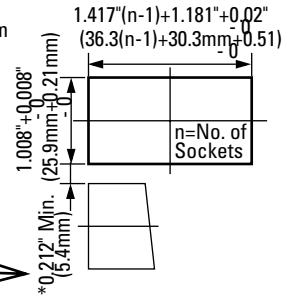

\*0.41" Minimum (10.5mm) when Hold-Down Spring is Used

F



**SH4B-51**

<b>Style</b>	14-blade, panel mount
<b>Terminal</b>	Solder
<b>Electrical Rating</b>	300V, 10A
<b>Compatible Relay</b>	RH4B
<b>Hold-Down Spring</b>	SY4S-51F1, SY4S-02F1
<b>Hold-Down Clip</b>	SFA-301, SFA-302

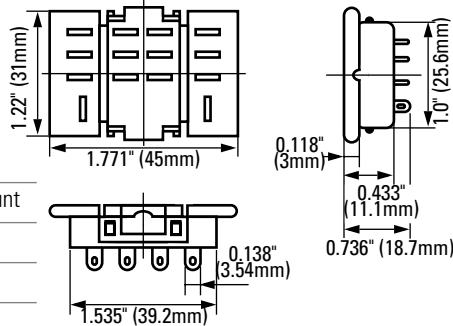

**Terminal Arrangement**

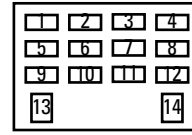

As Viewed from the Bottom

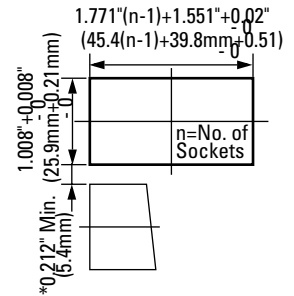

\*0.41" Minimum (10.5mm) when Hold-Spring is Used



1. For socket mounting accessories, see page F-24.
2. For hold-down clip/spring selections, see page F-4.